

OEIS A342447

RICHARD J. MATHAR

ABSTRACT. This manuscript illustrates the Hasse diagrams complete up to  $V = 6$  elements /nodes refined according to the number  $E$  of arcs [2, A000112,A342447].

The Hasse diagrams are not necessarily connected. To avoid confusion of which nodes are in which diagram, we surround each diagram with a solid frame.

Each diagram is followed by 3 integer parameters:

- $d$  is the “diameter”, the longest path along the oriented edges.  $1 + d$  is the length of the “longest chain” which counts not the arcs along the path but the nodes/vertices [2, A263859].
- $R$  is the number of order relations [1, §1.16] related to the graph. It is the number of arcs in the Hasse diagram,  $E$ , plus the number of arcs (possibly zero) that are added if the transitive closure of the incidence matrix is computed, plus the number of nodes,  $V$ , to comply with the reflexive cases (1’s on the diagonal of the incidence matrix).
- $A$  is the order of the automorphism group (the number of permutations of rows and columns that keep the incidence matrix fixed). This is an aid to enumerate the labeled diagrams.

1 DIAGRAM ON  $V = 1$  NODE



2 DIAGRAMS ON  $V = 2$  NODES

1 diagram with 0 arcs.   $d=0$   $R=2$   $A=2$

1 diagram with 1 arc.   $d=1$   $R=3$   $A=1$

5 DIAGRAMS ON  $V = 3$  NODES

1 diagram with 0 arcs.   $d=0$   $R=3$   $A=6$

1 diagram with 1 arc.   $d=1$   $R=4$   $A=1$

---

*Date:* March 15, 2021.

*2010 Mathematics Subject Classification.* 06A07.

*Key words and phrases.* Combinatorics, Posets, Hasse Diagrams.

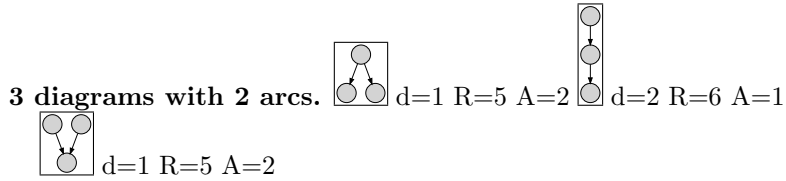
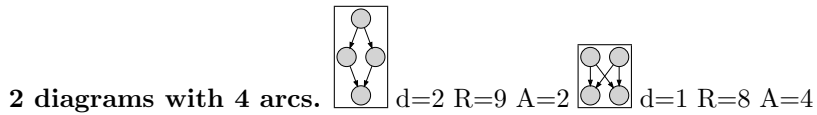
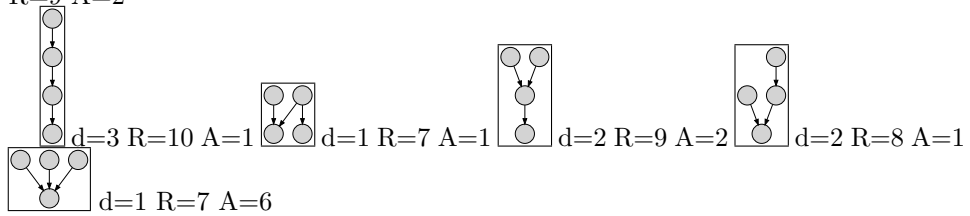
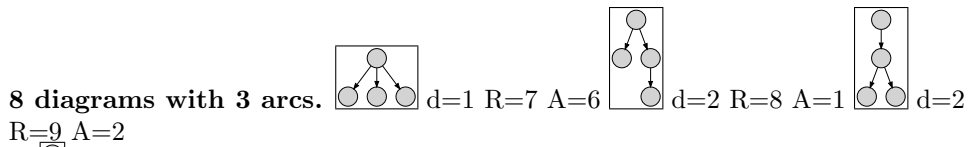
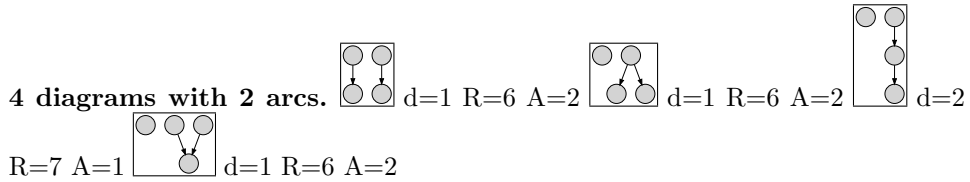
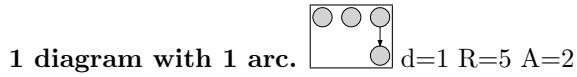
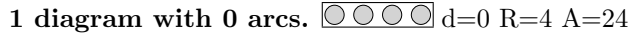
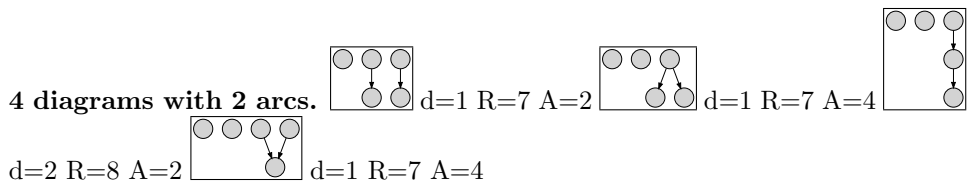
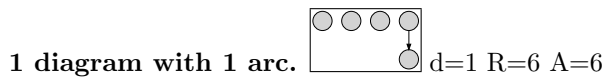
16 DIAGRAMS ON  $V = 4$  NODES63 DIAGRAMS ON  $V = 5$  NODES

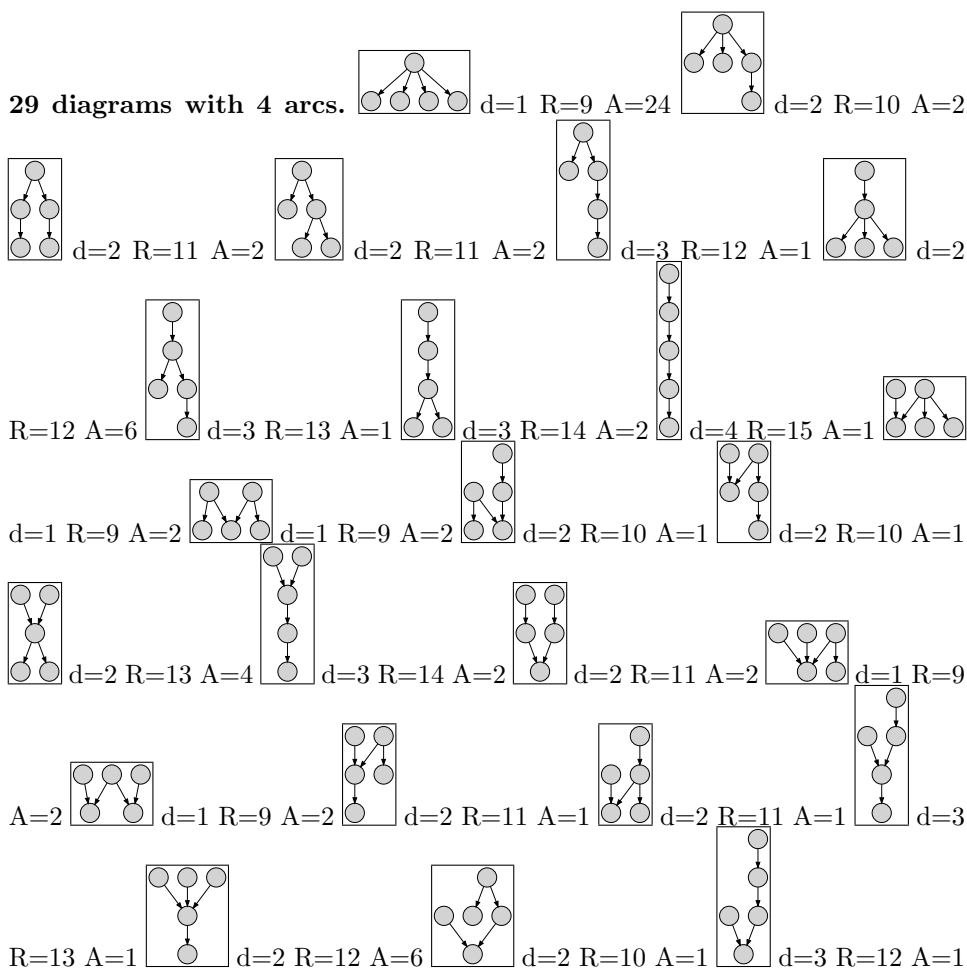
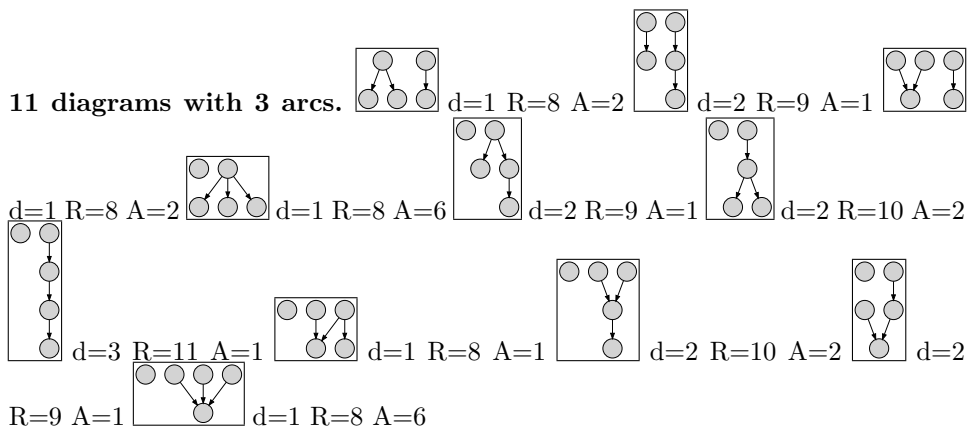

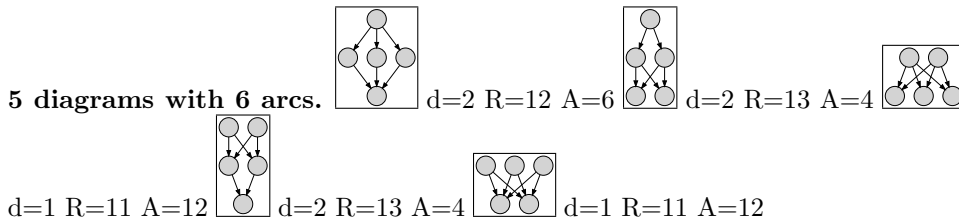
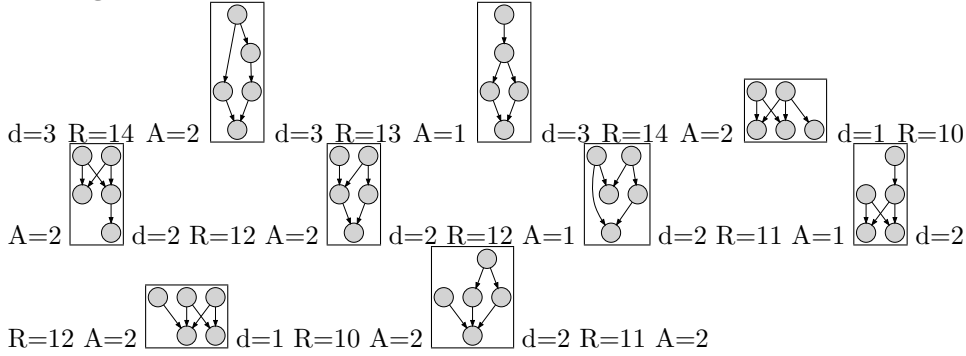
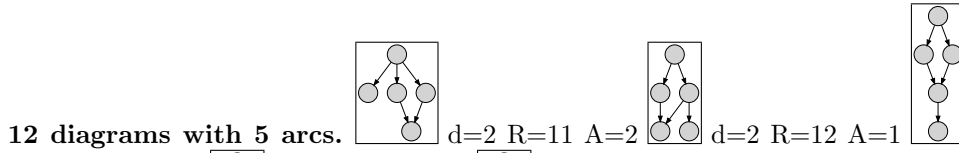
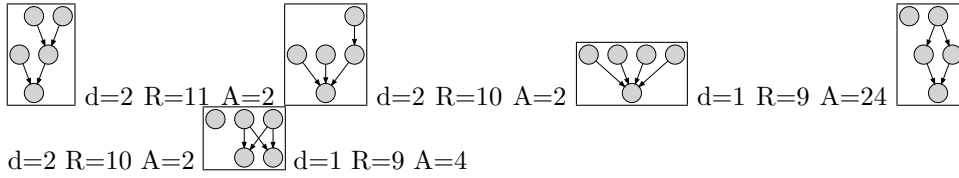
318 DIAGRAMS ON  $V = 6$  NODES

**1 diagram with 0 arcs.** d=0 R=6 A=720

**1 diagram with 1 arc.** d=1 R=7 A=24

**4 diagrams with 2 arcs.**

d=1 R=8 A=4    d=1 R=8 A=12    d=2 R=9 A=6    d=1 R=8 A=12

**12 diagrams with 3 arcs.**

d=1 R=9 A=6    d=1 R=9 A=2    d=2 R=10 A=1    d=1 R=9 A=2    d=1 R=9 A=12    d=2 R=10 A=1    d=1 R=9 A=2    d=1 R=9 A=12    d=2 R=10 A=1    d=1 R=9 A=2    d=1 R=9 A=12    d=2 R=10 A=1

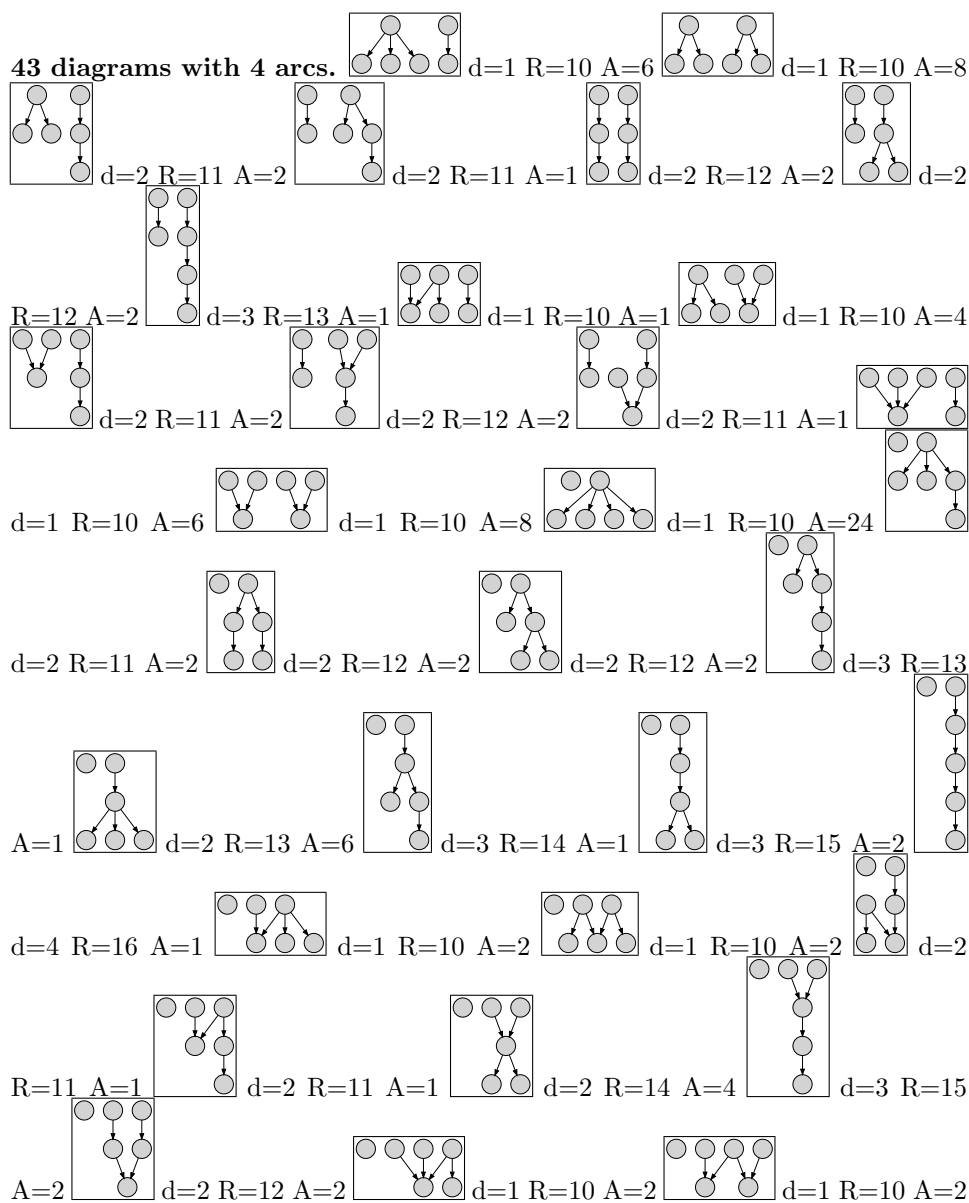
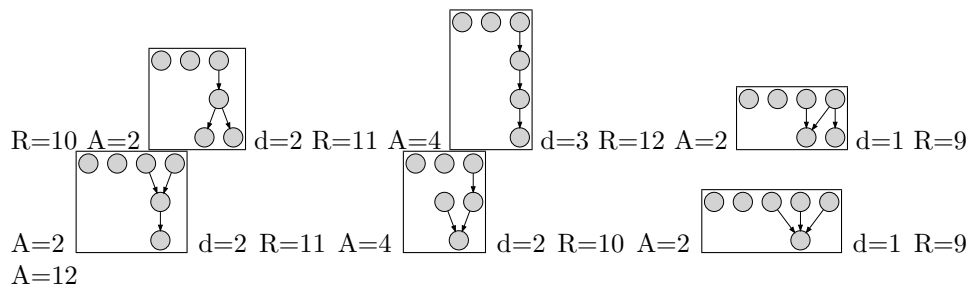

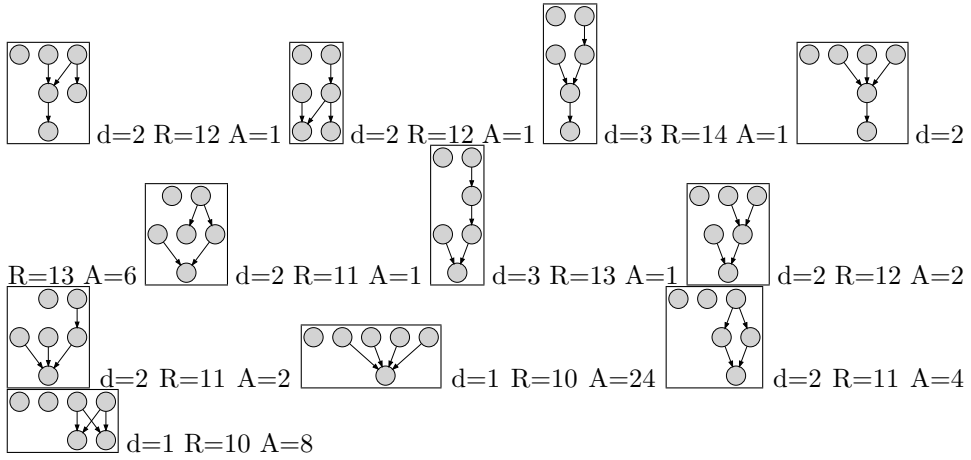
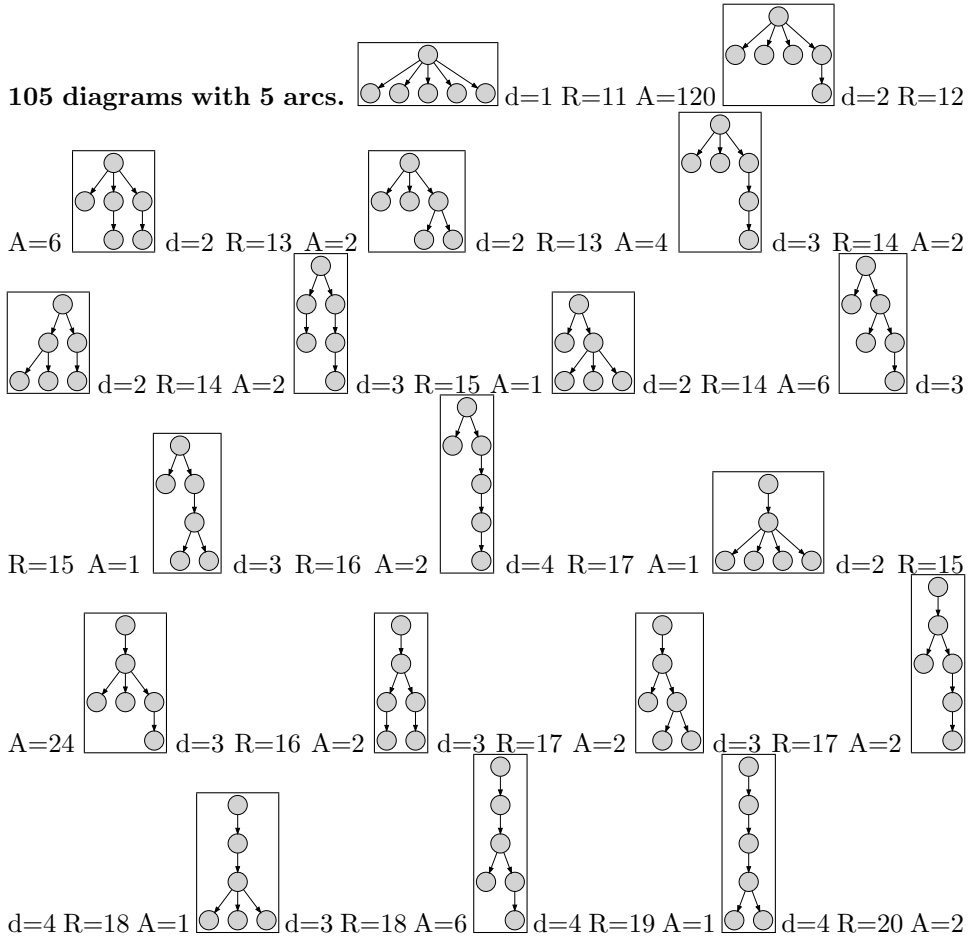
**105 diagrams with 5 arcs.**

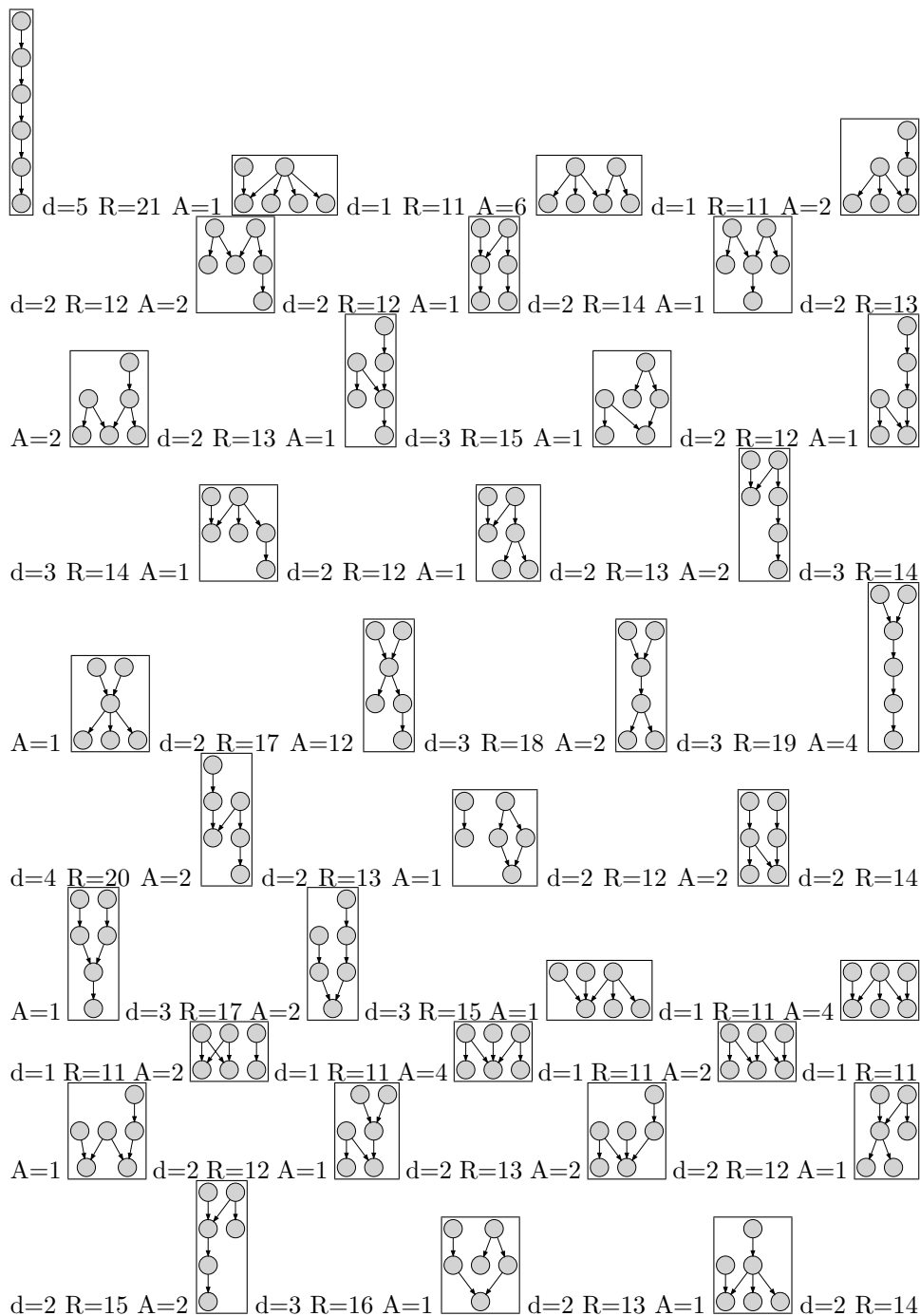

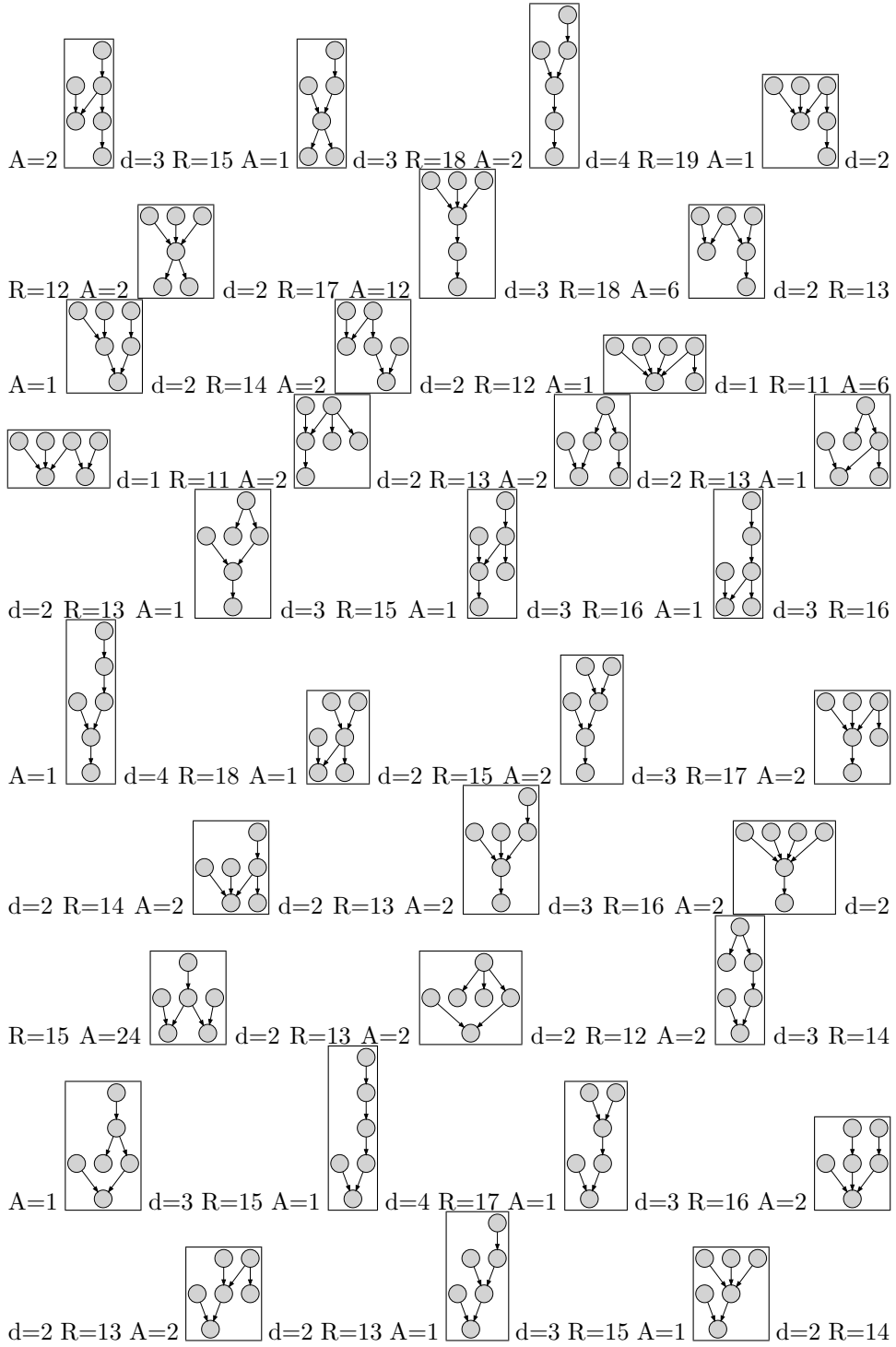



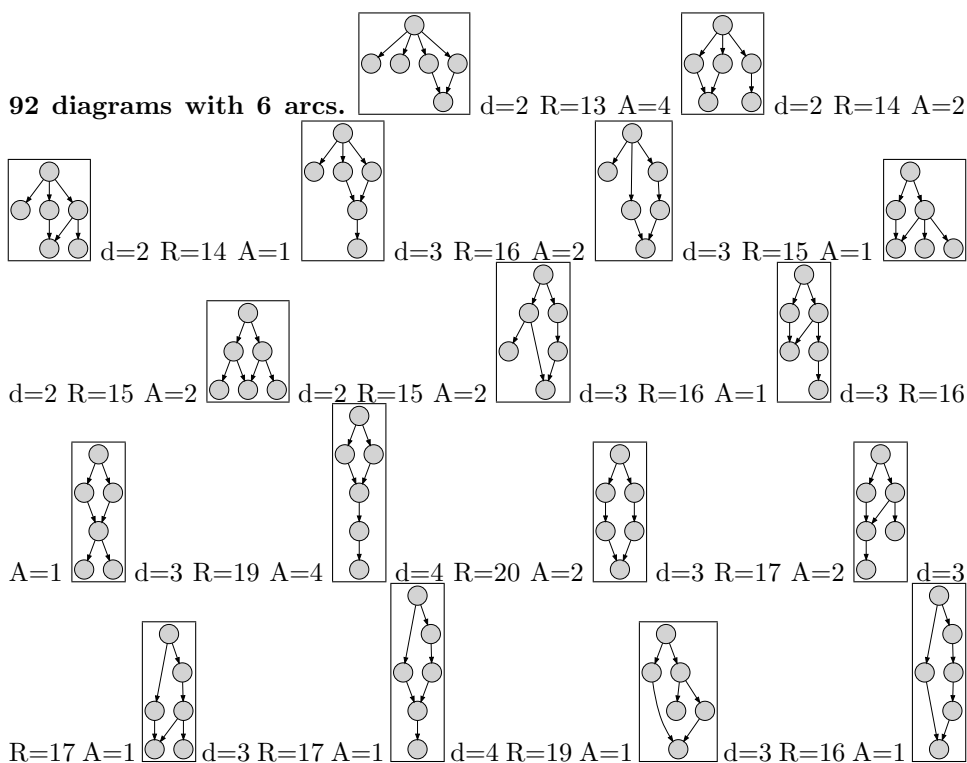
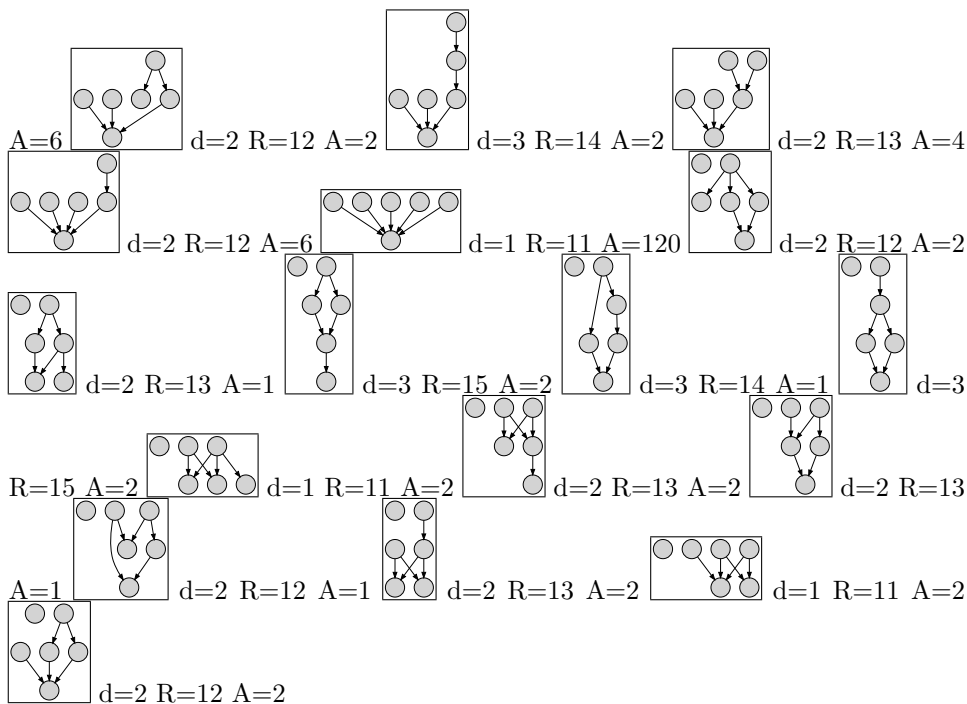

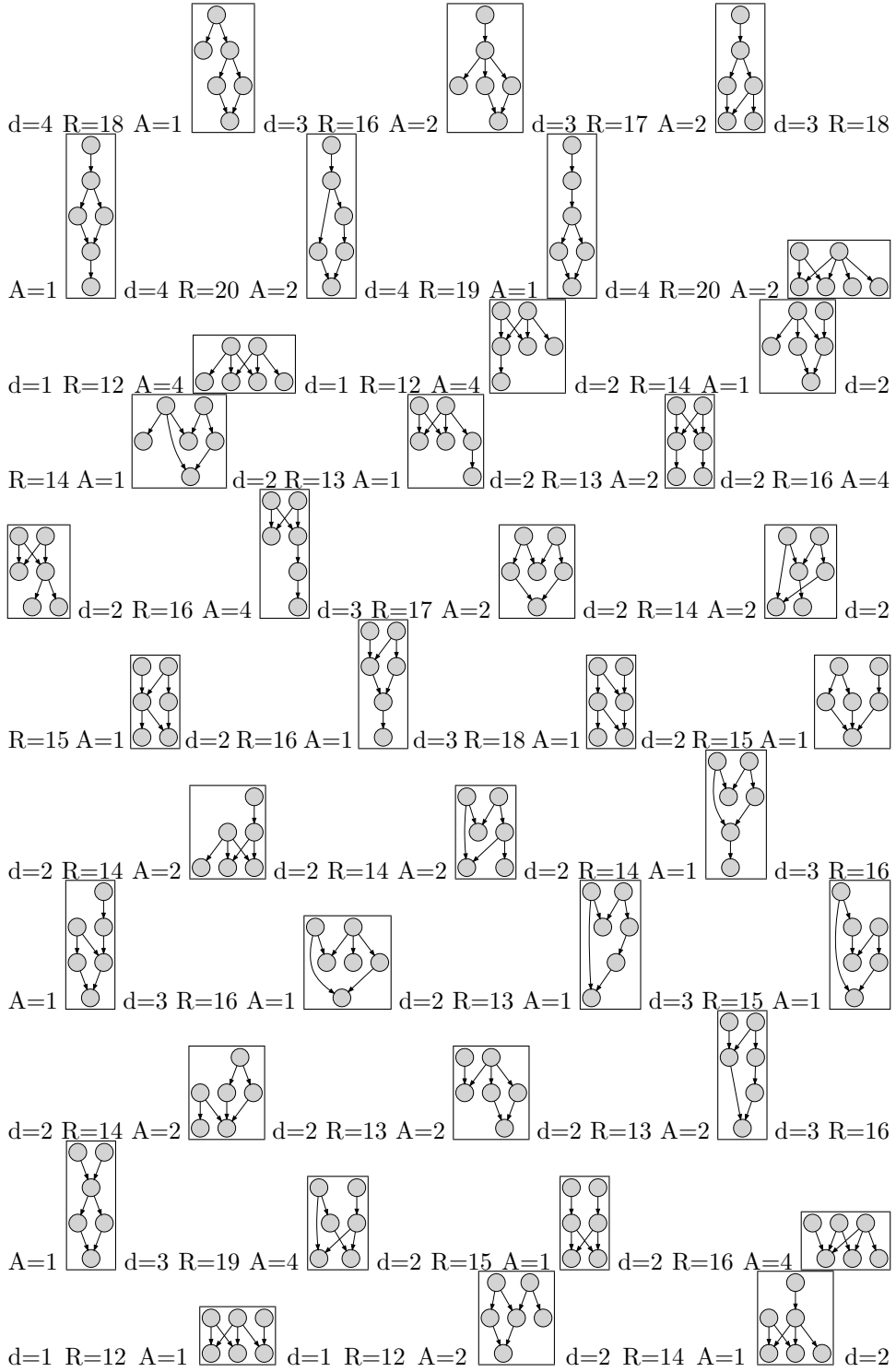

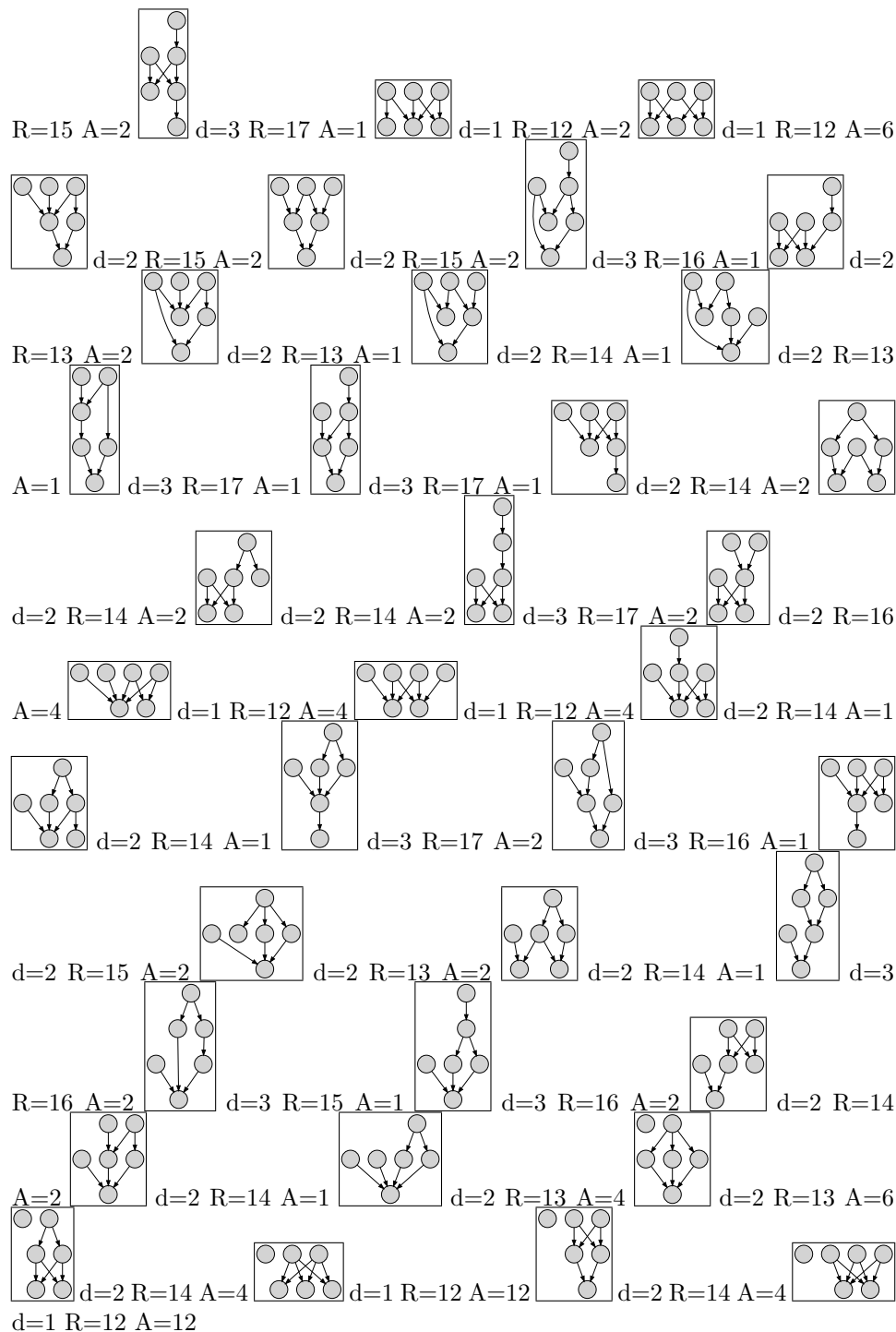

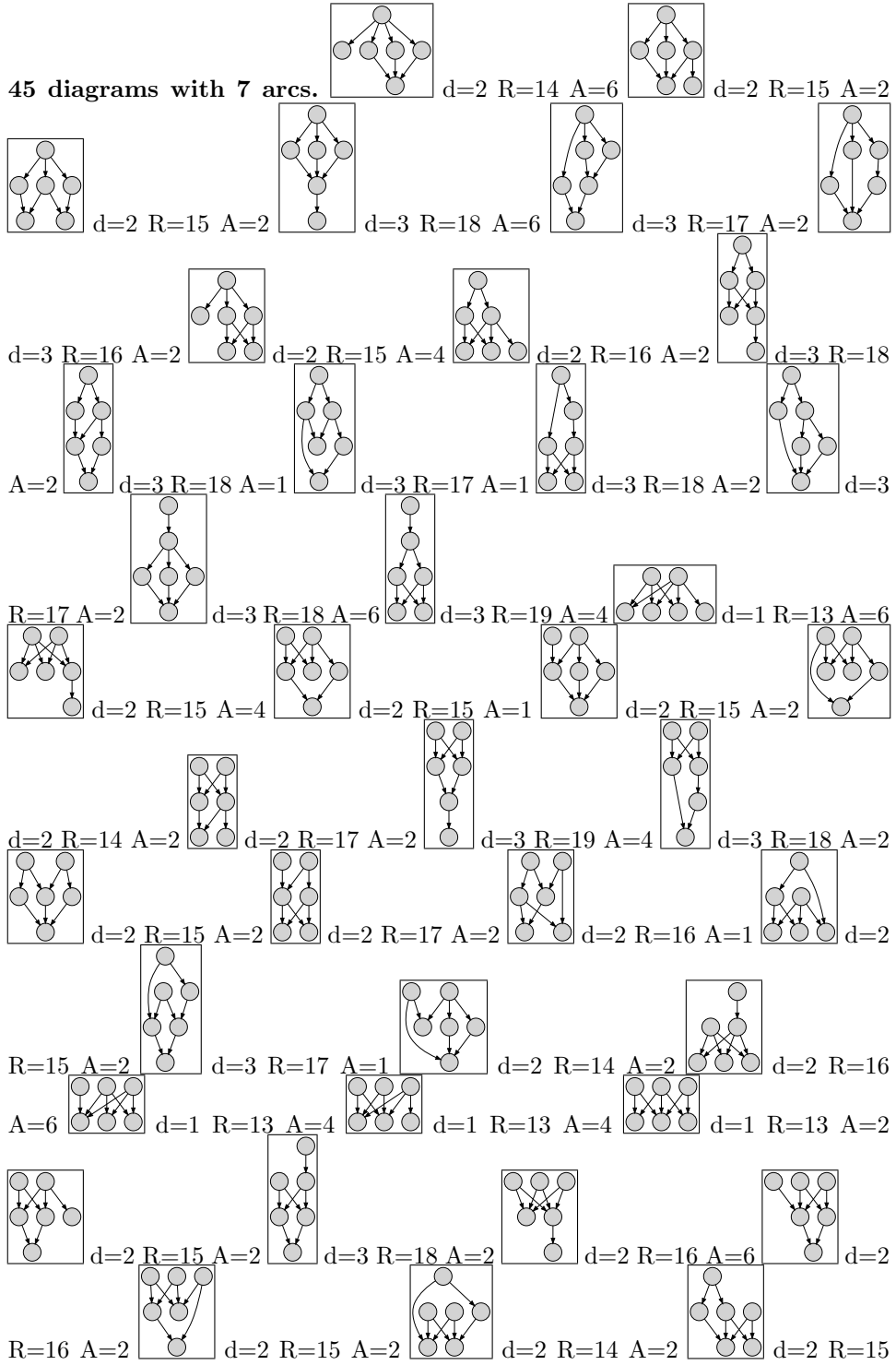

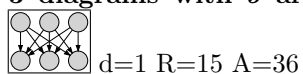
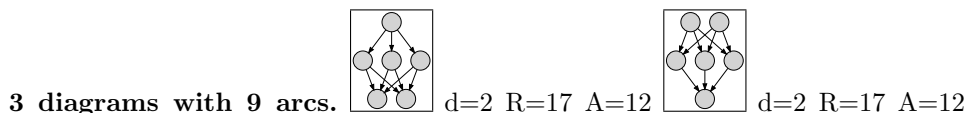
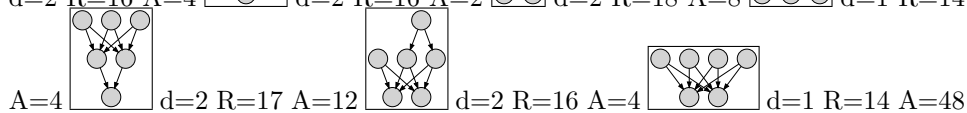
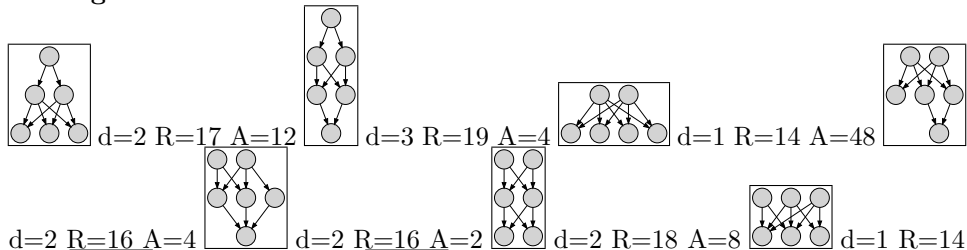
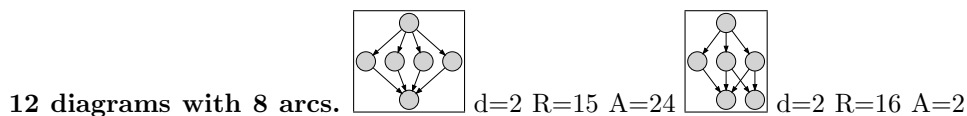
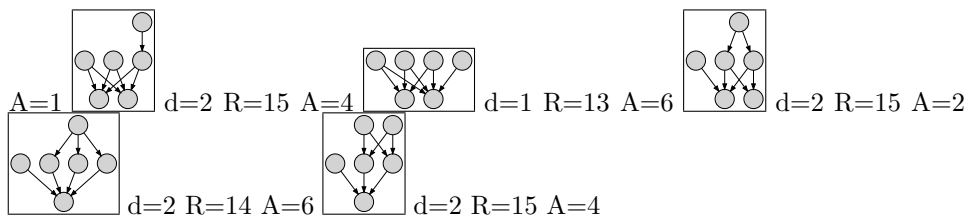

REFERENCES

1. Louis Comtet, *Advanced combinatorics*, Springer, Berlin, Heidelberg, New York, 1974.
2. O. E. I. S. Foundation Inc., *The On-Line Encyclopedia Of Integer Sequences*, (2020), <https://oeis.org/>. MR 3822822  
 URL: <http://www.mpia-hd.mpg.de/~mathar>

MAX-PLANCK INSTITUTE OF ASTRONOMY, KÖNIGSTUHL 17, 69117 HEIDELBERG, GERMANY